

INSTALLATION GUIDE

The SAVW01 allows for the retention of the steering wheel controls as well as other vital features when installing an aftermarket unit into the vehicle. This interface features selectable dipswitches for dedicated applications, simply refer to the provided table for the correct configuration ensuring seamless integration.

VEHICLE APPLICATION

SKODA	
Octavia (1Z)	2009 - 2013
Rapid (NH)	2012 - 2015
Roomster (5J)	2010 - 2015
Superb (3T)	2008 - 2013
Yeti (5L)	2009 - 2013

VOLKSWAGEN	
Caravelle (7H)	2009 - 2015
CC (3C/35)	2012 - 2016
Eos (1F)	2010 - 2015
Golf VI (1K)	2008 - 2016
Golf VI (1KM)	2009 - 2013
Golf VI Plus (1KP)	2009 - 2014
Multivan (7H)	2009 - 2015
Passat B7 (3C/362)	2010 - 2014
Polo V (6R)	2009 - 2014
Scirocco III (13)	2008 - 2014
Sharan II (7N)	2010 - 2015
T5 Transporter (7H)	2009 - 2015
Tiguan I (5N)	2011 - 2016
Touran (1T)	2010 - 2015

KEY FEATURES

- RETAIN STEERING WHEEL CONTROL FUNCTIONALITY
- REPLACE FACTORY RADIO
- MAINTAINS ACCESS TO SETTINGS THROUGH ON-SCREEN MENUS
- SUPPORTS PARKING CAMERA WITH OPS RADAR DISPLAY OVERLAY*
- ENABLES VISUALISATION OF CLIMATE CONTROL FUNCTIONS
- AUTO-DETECTS REVERSE CAMERA INPUT (PAL/NTSC)
- WORKS WITH FACTORY-INSTALLED FENDER AMPLIFIED SYSTEMS
- OUTPUTS FOR SPEED PULSE, PARK BRAKE & REVERSE
- SUPPORTS ENGLISH, GERMAN, SPANISH, ITALIAN, FRENCH
- SOFTWARE UPDATEABLE

*AFTERMARKET CAMERA SOLD SEPARATELY. ADDITIONAL INTERFACE MAY BE REQUIRED FOR OEM CAMERA RETENTION.

Quadlock (Fakra) Connector
For vehicles with white MFD display only

This harness allows for the retention of the steering wheel controls as well as other vital features when installing an aftermarket unit into a vehicle. This interface features selectable dipswitches for dedicated applications, simply refer to the provided table for the correct configuration ensuring seamless integration. Installation requires a certain level of technical knowledge. Prior to installation please read this manual in its entirety.

It is essential to use the correct tools during installation to prevent any damage to the vehicle or the product itself.

Please note that we cannot be held liable for any issues arising from improper installation.

Before proceeding with installation, disconnect the negative battery terminal and ensure the key is removed from the ignition.

CONNECTION DIAGRAM

HEAD UNIT CONNECTION LEAD

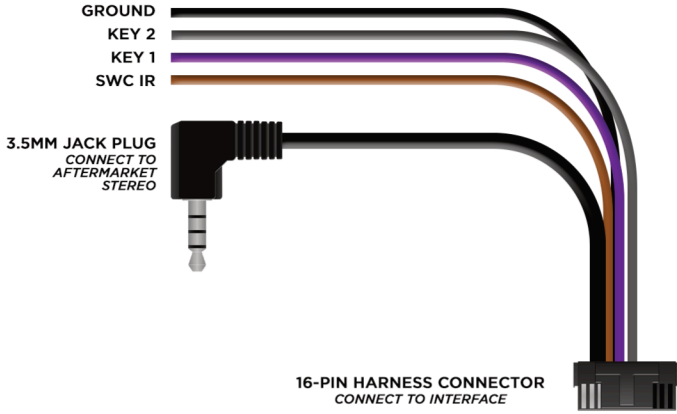

SWC INTERFACE

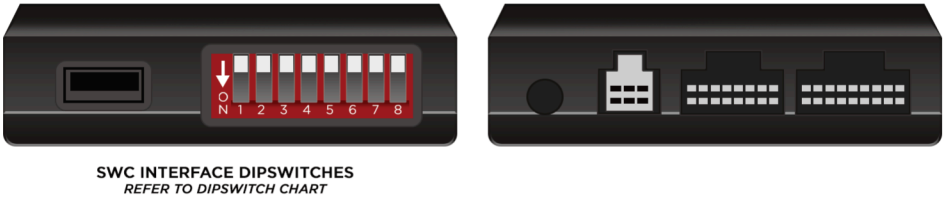

SWC VEHICLE HARNESS

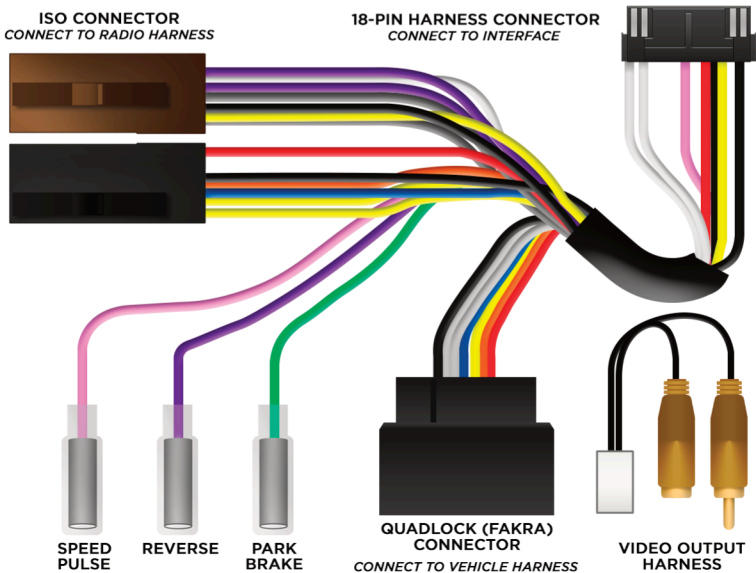

CONNECTION GUIDE

BEFORE INSTALLATION

Prior to installing the interface, it is essential to remove and disconnect the factory stereo. For guidance on this process, please refer to the vehicle owner's manual/handbook or seek assistance from a professional.

SETTING THE DIPSWITCHES

This interface includes a set of dipswitches. Consult the dipswitch selection guide to select the appropriate configuration. To activate a dipswitch, press it downward into the 'ON' position. Refer to the diagram for an example of the 'KENWOOD' dipswitch configuration.

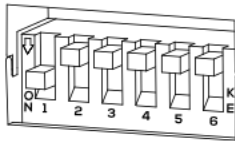

INSTALLATION

1. Take the interface, then connect the 16-PIN head unit connection lead and the 18-PIN steering wheel harness connectors to their respective ports.

2. Connect the head unit connection lead to the steering wheel remote input on the rear side of the aftermarket stereo. Connection methods vary based on the stereo brand, utilising either a 3.5mm jack connector SWC IR wire or wired inputs KEY1 and KEY2. *For specific connection guidance, refer to your aftermarket stereo's installation manual if not clearly labelled on the stereo harness.*

3. Connect the power/speaker ISO connector from the interface to the corresponding power/speaker ISO connection on the aftermarket stereo.

For aftermarket stereos lacking an ISO connector, refer to the "Wiring Key" on Page 2 for guidance on connecting wires. Certain interfaces may also include extra "flying" wires for additional functionalities such as parking brake trigger, reverse gear, and speed pulse. Further information on these wires is available in the "Flying Wire Wiring Key" section.

4. Connect the vehicle-specific connectors from the interface harness to the corresponding connectors on the vehicle harness.

5. Connect the flying wires on the harness to the rear of the stereo (if applicable).

6. Connect the antenna adapter to the vehicle's existing connection at the rear of the aftermarket stereo.

7. When installing an aftermarket reverse camera, connect the yellow RCA from the harness to the yellow RCA of the aftermarket camera. (If supported by the interface and vehicle)

8. When installing a DAB antenna, ensure to connect the DAB aerial connector to the rear of the new stereo.

9. Ensure the reverse camera is enabled on the aftermarket radio and that the reverse trigger wire is connected to the reverse wire.

10. After connecting all wires (along with any additional accessories), it's crucial to thoroughly test the stereo and steering wheel controls before reassembling the dashboard. If steering wheel controls are unresponsive, inspect connections and check dipswitch settings. Repeat the connection process if necessary, following the outlined steps.

USB UPDATE LEAD - Connect the USB lead to the interface and route it to an accessible location for future software updates.

STEERING WHEEL CONTROL CONFIGURATION

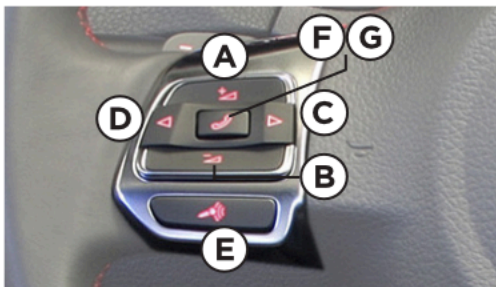

- | | |
|----------------------|-----------------------|
| A Volume Up | E Mute / Voice |
| B Volume Down | F Pick Up |
| C Track Up | G Hang Up |
| D Track Down | |

MENU NAVIGATION

Hold **C** to **access** the vehicle menu

Short press **A** and **B** to **navigate** through the menu

Short press **C** or **D** to **select** a menu option

The provided diagram, while meticulously researched, serves as an example only. Actual steering wheel control configurations may vary dependant on each vehicle.

WIRING KEY

ISO CONNECTOR WIRING KEY	Purple	Right Rear Speaker +	Grey	Right Front Speaker +	Yellow	Permanent 12V
	Purple/Black	Right Rear Speaker -	Grey/Black	Right Front Speaker -	Black	Ground
	Green	Left Rear Speaker +	White	Left Front Speaker +	Red	Ignition 12V
	Green/Black	Left Rear Speaker -	White/Black	Left Front Speaker -	Orange	Illumination
FLYING WIRE WIRING KEY OUTPUTS & RATINGS	Pink	Speed Pulse - 0 to 12V Square Wave @ 1Hz/Kph	Purple/White	Reverse Gear - 250mA		
	Green	Park Brake	Orange	Illumination - 250mA		
	Standby Current	<3mA	Operating Voltage	6V to 16V	Operating Temperature	-20C to 85C <small>*rated at 25 degrees Centigrade</small>

DIPSWITCH CONFIGURATION

MANUFACTURER	SYSTEM	DIPSWITCH CONFIGURATION				CONNECTION
		1	2	3	4	
RESERVED	NA	OFF	OFF	OFF	OFF	SOFTWARE UPDATE MODE
AERPRO	Analog	OFF	OFF	ON	ON	MALE 3.5MM JACK
ALPINE	IR DATA	OFF	ON	OFF	OFF	MALE 3.5MM JACK
ANALOG SINGLE EXTEND	Analog	ON	ON	ON	ON	BROWN SWC IR
ANALOG SINGLE WIRE	Analog	ON	ON	ON	OFF	BROWN SWC IR
CLARION	IR DATA	ON	OFF	OFF	ON	MALE 3.5MM JACK
CUSTOM	IR DATA	ON	OFF	ON	OFF	HEAD UNIT DEPENDANT
GRUNDIG	IR DATA	OFF	ON	OFF	ON	BROWN SWC IR
JVC	IR DATA	OFF	OFF	ON	OFF	BROWN SWC IR
KENWOOD 1	IR DATA	ON	OFF	OFF	OFF	BROWN SWC IR
KENWOOD 2	IR DATA	ON	ON	OFF	OFF	BROWN SWC IR
KEY 1 / KEY 2	Analog	OFF	ON	ON	OFF	KEY1 / KEY 2 WIRES
KEY 1 / KEY 2 EXTEND	Analog	OFF	ON	ON	ON	KEY1 / KEY 2 WIRES
PHILIPS	IR DATA	OFF	ON	OFF	ON	BROWN SWC IR
PIONEER 1	Analog	OFF	OFF	OFF	ON	MALE 3.5MM JACK
PIONEER 2	Analog	OFF	OFF	ON	ON	MALE 3.5MM JACK
SONY	Analog	ON	OFF	ON	ON	MALE 3.5MM JACK
ZENEC	IR DATA	ON	ON	OFF	ON	BROWN SWC IR

DIPSWITCH 5 to 8

Dipswitch 5 to 8 are reserved for vehicle specific configuration.

KEY1 and KEY2	KEY1 and KEY2 are specifically tailored for analog learning mode-style radios. Our SWC module is designed with a resistor chain that precisely matches the required resistance for seamless compatibility with this type of head unit.
KEY1 and KEY2 EXTEND	This mode extends every button press to 2 seconds during the learning process. However, with roll wheel-designed steering wheel buttons, holding for 2 seconds isn't feasible. Our KEY1 and KEY2 extend feature addresses this by automatically prolonging each press, simplifying head unit programming even in such scenarios. Extend mode is not intended for normal use, it is only used in the teaching process.
ANALOG SINGLE WIRE and ANALOG SINGLE WIRE EXTEND	This function operates similarly to KEY1 and KEY2 but transmits all unique values through the IR SWC single wire. This is crucial for compatibility with learning-style head units featuring only one learning input wire. To ensure compatibility, we've incorporated this feature into our steering wheel control interface, ensuring seamless operation across various head unit setups. The Analog Extend mode functions identically to its counterpart within the KEY1 and KEY2 system but transmits through a single wire.

VEHICLE SETTINGS, PARK ASSIST & CLIMATE

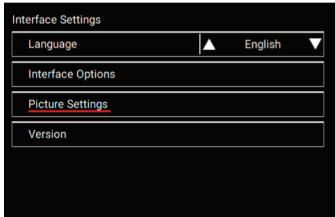

Interface Settings Select language. Supports English, German, Spanish, Italian, French

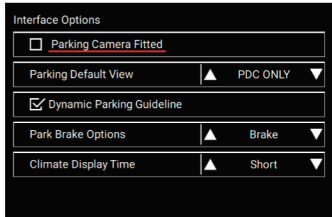

Interface Options Select parking camera, PDC and interface options.



Picture Settings Select picture setting options including position, brightness and contrast.



Audio Settings Adjust vehicle audio settings, including bass, mid, treble, and more - when equipped with an OEM amplifier.



Parking Display Parking camera with PDC overlay pictured. Parking display is triggered from the Reverse signal.

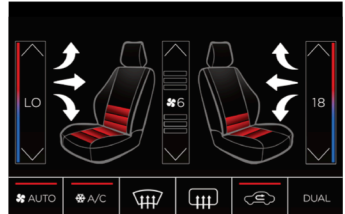

Climate Control Pictured: The display screen supporting the vehicle's climate control functions.

TECHNICAL SUPPORT

If you need assistance setting up or using your Audio Tech Direct product now or in the future, call Audio Tech Direct Support UK **TEL: 01691886130** MON-FRI 9AM - 5PM. If you would like to download a digital copy of this manual, or other Audio Tech Direct manuals visit www.audiotechdirect.com website.