



VAUXHALL VEHICLES

With 8" Navi900 Intellilink Nav System
installation guide



Available now at Audio Tech Direct

 www.audiotechdirect.com

Vauxhall vehicles

With 8" Navi900 Intellilink Nav System

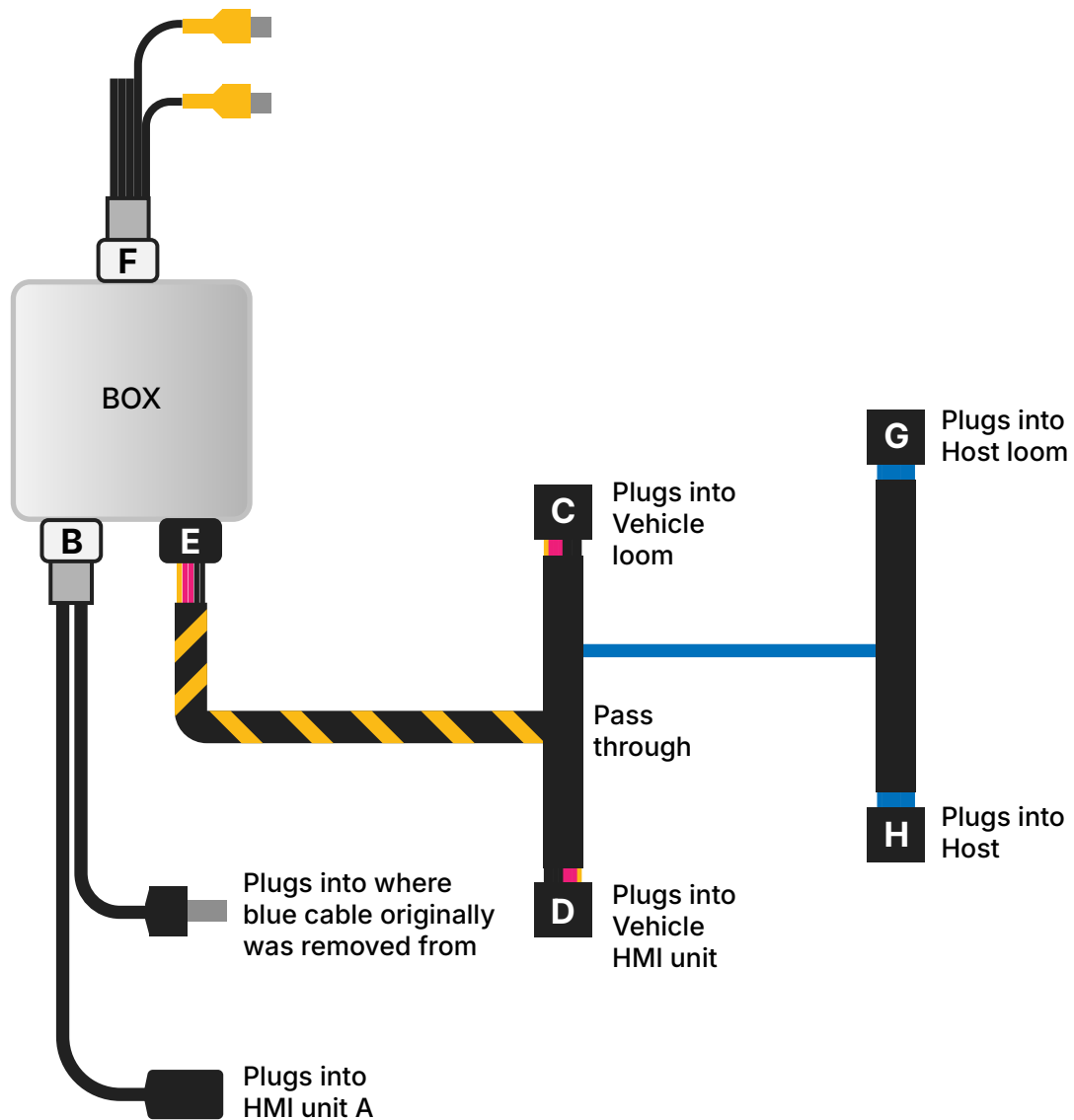

Navi900 Host unit location

CAN plug connection is made at the original radio host, which is located down in the drivers footwell.

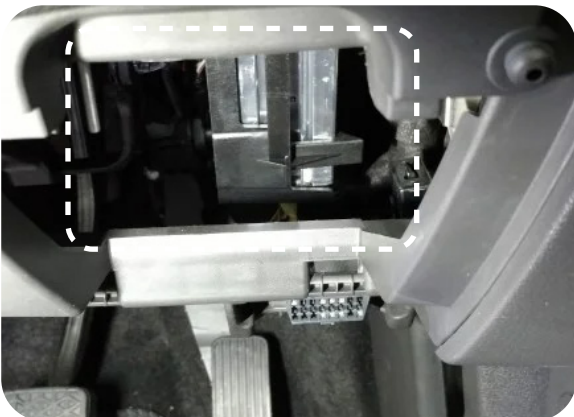

CAN connection Point

The CAN connection is made here.



Vauxhall Insignia

Reverse camera install



1
Remove screen
Remove radio

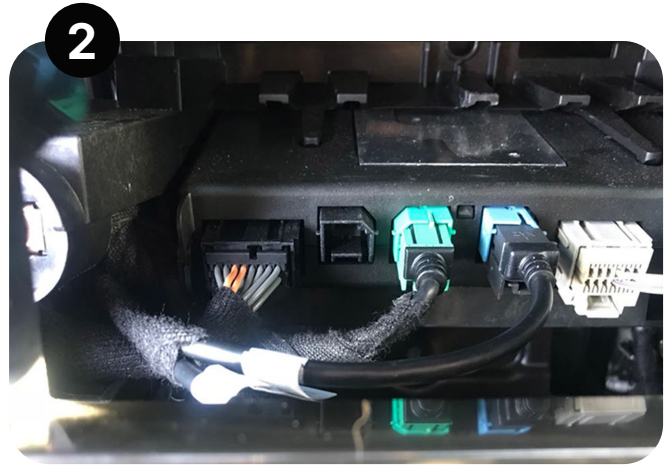

2
Remove heater Controls



3
Remove heater Controls mounting panel

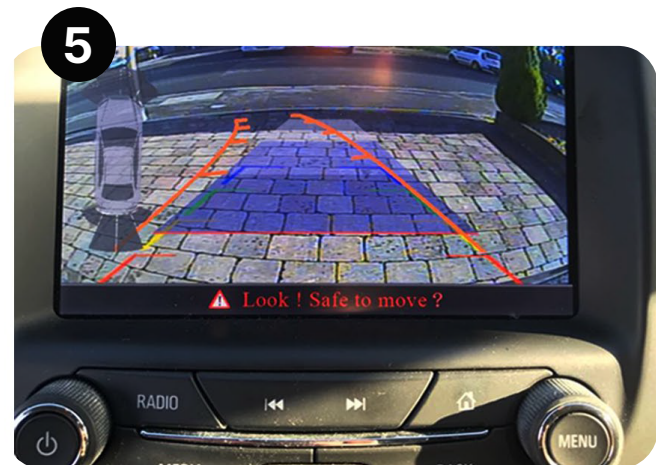

5

Opel/Vauxhall Astra

Reverse camera install guide

1



Remove fascia to gain access to the HMI unit. This is the black control unit in the vehicle which supplies video to the screen.

2



3



Remove fascia no. 1

4



Remove fascia no. 2

5



Drop steering column and remove fascia from behind steering wheel

6



Remove speedo unit

7



Initial configuration

8



Disconnect blue LVDS video plug from HMI unit

9



Connect blue LVDS cable to black video cable loom (A)

10



Connect other end of black video cable to Box (B)

11



Remove power loom from car

12

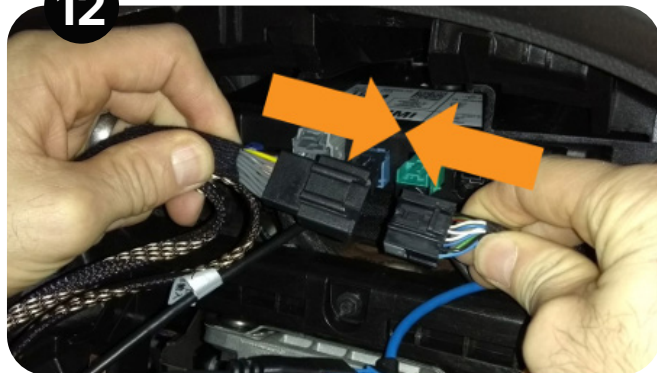

Connect black power loom into Pass Through (C)

13

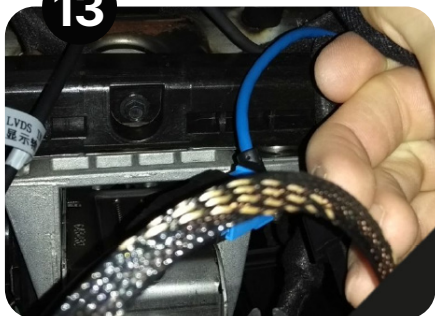

Connect other end of Pass Through into car (D)

14

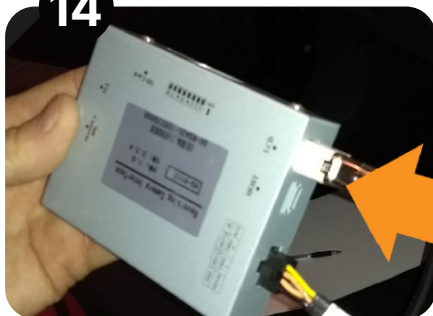

Connect box to remaining cable (E)

15

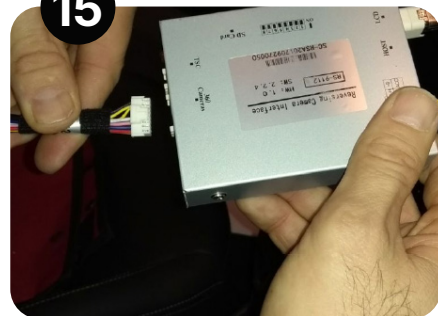

Connect to camera power loom (F)